

**Standard enclosure**  
Series CA

<b>Designation CA-350</b>	<b>Article number 135000000</b>
---------------------------	---------------------------------

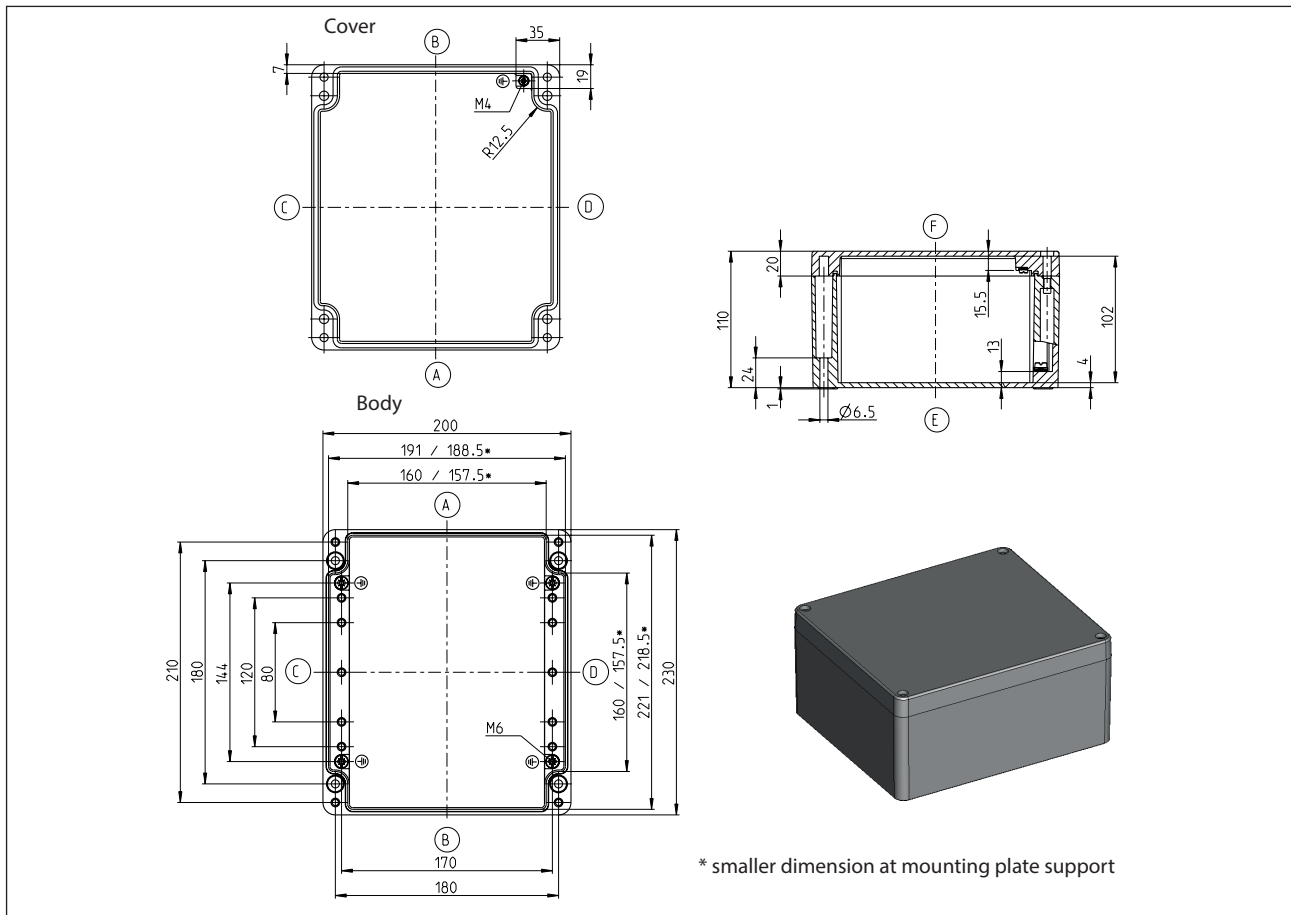

<b>Standard version</b>
Scope of supply:
Base of enclosure
Enclosure cover
Cover screws (cross recessed head) enclosed loosely
Earthing screws in the lower part and in the cover
Colour RAL 7001 (silver grey)
Cover gasket PUR (polyurethane)
Individually packaged in foil

<b>Maximum possible number of thread (figures for identical diameter, not mixed!)</b>								
ISO M	M12	M16	M20	M25	M32	M40	M50	M63
Page A/B	35	15	12	8	4	3	2	2
Page C/D	26	12	8	5	3	2	2	1

<b>Property chart CA-350</b>			
<b>Specification</b>	<b>Value</b>	<b>According to the standard</b>	<b>Remark</b>
<b>General data:</b>			
Weight	2730 g		
External dimensions	200 x 230 x 110		
Protection classes			
IP-code	IP66	EN 60529	
IP-code	IP67	EN 60529	
IK-code	IK09	IEC 62262	
Material			
Enclosure	EN AC-ALSi12Cu1(Fe) EN AC-44300	DIN EN 1706:05/98	Aluminium pressure die-casting Alloy 230
Screws	A2-70	DIN EN ISO 3506-1	Cover screws
Gasket	PUR (Polyurethan)		Colour: dark grey, 2-component polyurethane foam seal
Toxic behaviour	halogen-free		
<b>Mechanical properties:</b>			
Torques			
Cover screws	2,5 Nm		
Earthing screws	2,5 Nm 2,0 Nm		Body Cover
Attachment of accessories	2,5 Nm		for ex. mounting plates, mounting rails
Other mounting	2,5 Nm		Screw channel, External mounting brackets
Maximum installation weight	3,7 kg		
<b>Thermal properties:</b>			
Temperature range			
Enclosure without a seal	-30 °C bis +80 °C		Standard powder-coated enclosure
PUR-seal	-40 °C bis +100 °C		
Ambient temperature Indoor application	-5°C bis +40°C	DIN EN 62208	On the average over 24h +35°C
Thermal conductivity value	1,35 K/W		taking account of effective dissipation loss
Relative humidity			
Indoor application	max. 50% bei +40°C	DIN EN 62208	with low temperatures also higher (for ex. 90% at +20°C)
Storage temperature	-20°C bis +60°C		
<b>Chemical properties:</b>			
Corrosion resistance	Severity level A	DIN EN 62208/9.13.2.1	IEC 60068-2-30 and IEC 60068-2-11
Corrosion resistance	Severity level B	DIN EN 62208/9.12.2.1	IEC 60068-2-30 and IEC 60068-2-11
Resistance lists for enclosure materials and seals see catalog			

<b>Property chart CA-350</b>			
<b>Specification</b>	<b>Value</b>	<b>According to the standard</b>	<b>Remark</b>
<b>Electrical characteristics:</b>			
Protection class	I	EN 61140 / VDE 0140-1	 Protection by protective conductor
Rated voltage	max. 1000 V (AC) max. 1500 V (DC)		
<b>More details:</b>			
General tolerance	GTA 13/5	DIN 1688	Cast part tolerances
General tolerance	mH	ISO 2768	Machining tolerances
Product standard	Yes	DIN EN 62208	Empty enclosures for low-voltage switchgear assemblies
<b>Approvals</b>			
c UL us	Yes	UL508A / C22.2	Typ 1, 4, 4x, 12, 13
<b>Compliances</b>			
RoHs	compliant	Directive 2011/65/EU	
CE label	compliant	EG-Nr. 765/2008	
Low-Voltage-Directive No.:	2014/35/EU		

### Other versions / Accessories

The following information is not a standard. Approvals, compliances and protection classes of these versions upon request.

<b>Other versions CA-350</b>	
Description of the modification compared with the standard version	Article number
HF seal and cover screws	1350008000
Unwashed, not painted, loose accessories	1350017000
CR gasket	upon request
UV-resistant powder (outdoor installation)	upon request
Packed in cartons (screwed-in cover screws)	upon request

<b>Accessories / as individual parts or as assembly set</b>	
Description of the modification compared with the standard version	Article number
Mounting plate	9511015000
Mounting rail TS 15	-
Mounting rail TS 32	9821003000
Mounting rail TS 35	9822005000
Earthing rail	9810007000
External mounting brackets	9824023000
External articulated hinges	9801047000
Internal articulated hinges with cover guide (mechanical machining of the enclosure required)	9801030000

<b>Alternative seals</b>			
Specification	Value	According to the standard	Remark
<b>Thermal properties:</b>			
CR gasket	-30 °C bis +80 °C		IP66
Silicone foam seal	-60 °C bis +130 °C		IP66 / IP67
Silicone complete seal	-60 °C bis +200 °C		IP66 / IP67
EPDM seal	-35 °C bis +100 °C		IP66
HF seal	-55 °C bis +125 °C		upon request